

# An ADS 650 MHz medium beta cavity study and design

LIU Zhen-Chao(刘振超) GAO Jie(高杰) LI Zhong-Quan(李中泉) ZHAI Ji-Yuan(翟纪元)  
ZHAO Tong-Xian(赵同宪) LI Da-Zhang(李大章) LIU Yi-Lin(刘一霖) SUN Yi(孙毅)

Institute of High Energy Physics, Chinese Academy of Sciences, Beijing 100049, China

**Abstract:** The Accelerator Driven Sub-critical System (ADS) is under development and aims at the safe disposal of nuclear waste and providing electric power in China. The main accelerator of the ADS is composed of two injector sections and one main linear acceleration section. The 650 MHz  $\beta=0.82$  superconducting cavities will be adopted to accelerate the proton bunches from 360 MeV to 1.5 GeV in the medium energy section. This paper presents the study and design results of this kind of superconducting cavity.

**Key words:** ADS, medium beta, high current, superconducting cavity

**PACS:** 29.20.Ej **DOI:** 10.1088/1674-1137/37/1/017005

## 1 Introduction

China is developing the Accelerator Driven Sub-critical System (ADS), whose objective is the safe disposal of nuclear waste and provision of electric power. This facility is composed of a nuclear reactor operating in subcritical mode and a main linac providing the required complement neutrons. The facility makes it possible to utilize thorium (Th-232) as a nuclear fuel since it is three times as abundant in the Earth's crust as uranium and transmutes the long-lived transuranic radionuclides formed by neutron capture in a conventional reactor to short-lived radionuclides such as fission products. The ADS is a good choice for solving future energy shortage by the safe utilization of nuclear power. Over the last

two years, Chinese Academy of Sciences (CAS) has promoted the ADS as a major initiative within the long-term energy strategy for China. Fig. 1 shows the schematic of the ADS proton linac project. The option to accelerate the proton bunch in the medium energy range is to utilize the 650 MHz  $\beta=0.63$  and the  $\beta=0.82$  superconducting cavity. IHEP has started developing SRF technology about eight years ago. The large grain single cell niobium cavities reached 40 MV/m by BCP and 48 MV/m by EP separately in 2008. In 2010, one 9-cell low-loss large grain niobium cavity was fabricated and tested. The cavity reached 20 MV/m in the first vertical test at KEK [1]. A 650 MHz  $\beta=0.82$  superconducting cavity was studied and designed for the energy range from 360 MeV to 1500 MeV.

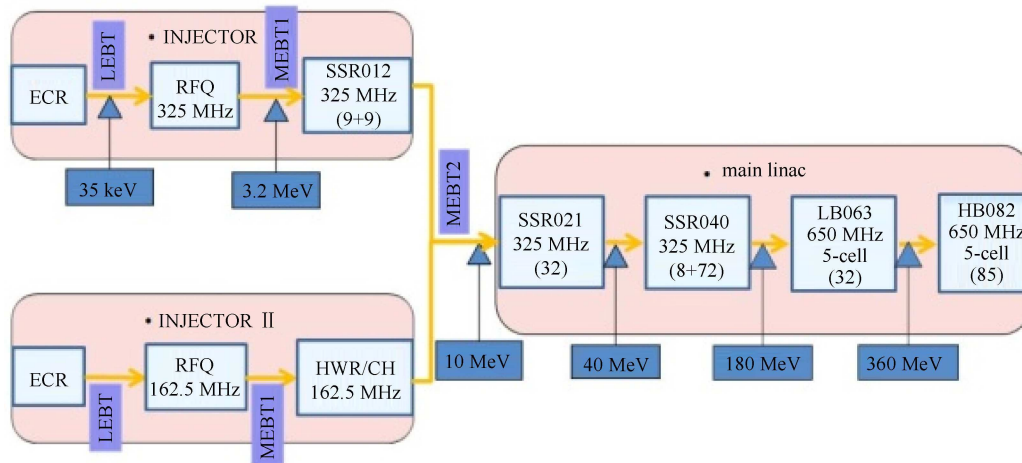

Fig. 1. The road map of ADS linac project.

Received 2 March 2012

©2013 Chinese Physical Society and the Institute of High Energy Physics of the Chinese Academy of Sciences and the Institute of Modern Physics of the Chinese Academy of Sciences and IOP Publishing Ltd

## 2 The design principle

The 650 MHz  $\beta=0.82$  superconducting cavity is used to accelerate proton bunches from 360 MeV to 1500 MeV. In this energy region, the particles still move at a speed lower than the velocity of light. A  $\beta=0.63$  cavity for the energy range of 180 MeV to 360 MeV. To accelerate 10 mA CW proton bunches, we need to follow these principles in the cavity design:

1) Proper cell numbers. A cavity with high cell numbers has low accelerating efficiency while a cavity with low cell numbers has a short accelerating length. Fig. 2 shows the accelerating efficiency for different cell numbers [2] and we choose a 5-cell cavity to balance the efficiency and accelerating length.

2) To get a higher accelerating gradient,  $E_{pk}/E_{acc}$  and  $B_{pk}/E_{acc}$  should be low.

3) No hard multipacting barrier is caused by shape.

4) Proper beam aperture is used to damp high order modes.

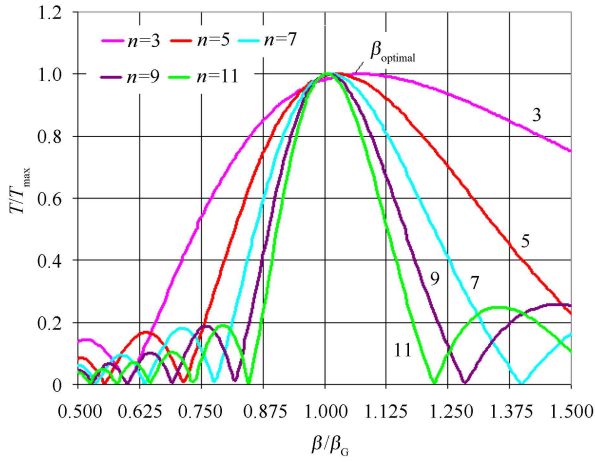

Fig. 2. Transit time factor versus a ratio of beam velocity  $\beta$  to geometrical  $\beta$  for different cavity cell numbers [2].

Table 1. The 650 MHz  $\beta=0.82$  superconducting cavity parameters.

type	elliptical
operating frequency/MHz	650
working gradient/(MV/m)	15
$Q_0$	$1 \times 10^{10}$
$\beta$	0.82
No. of cell	5
Dia. of iris/mm	100
cavity length/mm	1286.1
beam tube length/mm	180/160
$(R/Q)/\Omega$	514.6
$Q_0 \times R_s/\Omega$	235.5
$E_{pk}/E_{acc}$	2.12
$(B_{pk}/E_{acc})/(mT/(MV/m))$	4.05
field flatness (%)	>98
$K(\%)$	0.9

A 650 MHz  $\beta=0.82$  superconducting cavity was studied and designed using code BuildCavity [3] and Superfish. The cavity parameters are shown in Table 1. The cell shape parameters are shown in Table 2.

Table 2. The 650 MHz  $\beta=0.82$  superconducting cavity cell shape parameters.

parameters	center cell	end cell
$L/cm$	9.461	9.461
iris/cm	5	5
$D/cm$	20.0207	20.0207
$A/cm$	7.027	7.166
$B/cm$	7.027	7.883
$a/cm$	1.681	1.667
$b/cm$	2.522	2.501
$\alpha/(\circ)$	7	6.678

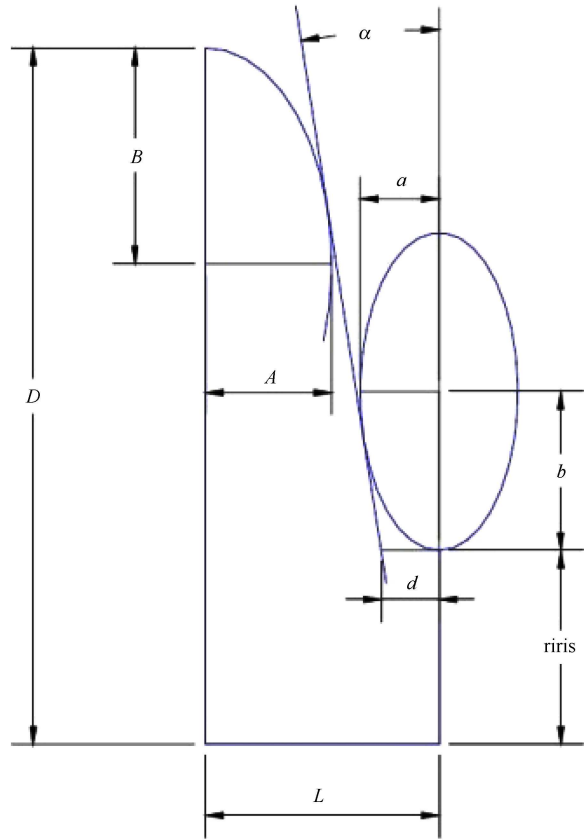

Fig. 3. The definition of cell shape parameters.

## 3 Multipacting

To achieve a high accelerating gradient, one needs to eliminate the hard multipacting barrier in the cavity. Using a proper cavity shape can stop multipacting from happening in the cavity. We use Track3P [4] to simulate the multipacting in the cavity. Several emission models for thermal, field and secondary emissions

have been implemented in Track3P. It can trace particle trajectories in structures excited by resonant modes, steady-state or transient fields, which are taken as inputs obtained by other high-accuracy field solvers built in the finite-element code suite such as Omega3P for standing wave cavity.

The criterion of a multipacting event is that the particle resonant trajectories have successive impact energies within the right range for a secondary emission yield (SEY) bigger than unity. Fig. 4 shows the SEY of normal niobium.

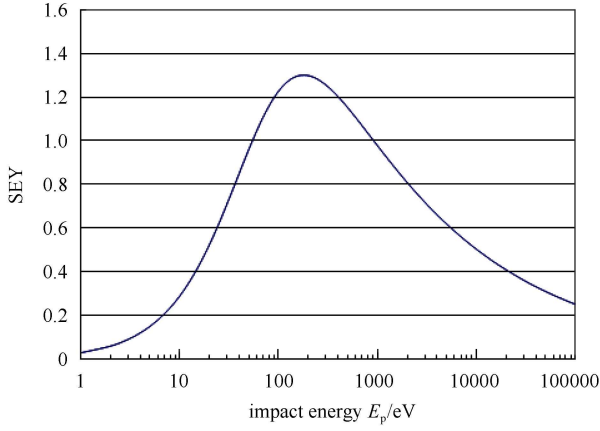

Fig. 4. SEY of normal niobium.

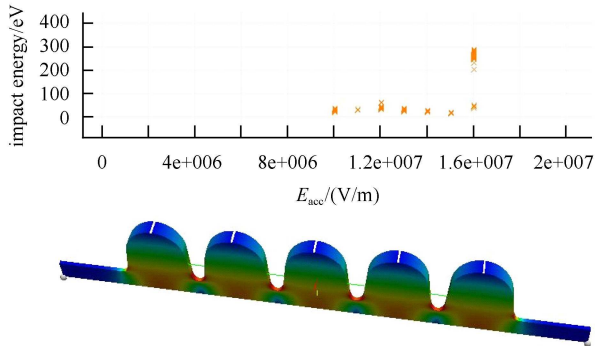

Fig. 5. The impact energy versus  $E_{acc}$  of the 650 MHz  $\beta=0.82$  superconducting cavity (up), the total resonant points (white points) when  $E_{acc}$  is from 10 MV/m to 16 MV/m (down).

We simulate the multipacting of the 650 MHz  $\beta=0.82$  cavity for  $E_{acc}$  from 1 MV/m to 20 MV/m with an interval of 1 MV/m using a ten degree slice of the cavity. Resonant trajectories only happen from 10 MV/m to 16 MV/m as shown in Fig. 5. For 10 MV/m to 15 MV/m, the impact energies are below 100 eV and that will not cause multipacting. The impact energies of resonant points are around 300 eV at 16 MV/m, however, there are only several points on the cavity. So no hard multipacting barrier happens at 16 MV/m.

## 4 The external $Q$ of the power coupler port

The external  $Q$  of the input power coupler port should be optimized to minimize the generator power, which is determined by Eq. (1) [5]. The RF power needed for the 650 MHz  $\beta=0.82$  superconducting cavity versus different external  $Q$  of power coupler is shown in Fig. 6, from which we can obtain the optimum external  $Q$  is in the range of  $1 \times 10^6$  to  $4 \times 10^6$ .

$$P_g = \frac{V_c^2}{R_{sh}} \frac{1}{4\beta} \left\{ (1+\beta+b)^2 + [(1+\beta)\tan\psi - b\tan\phi]^2 \right\}. \quad (1)$$

And

$$b = \frac{R_{sh} i_0 \cos\phi}{V_c}. \quad (2)$$

$$\tan\psi = -2 \frac{Q_0}{1+\beta} \frac{\Delta\omega}{\omega_0}. \quad (3)$$

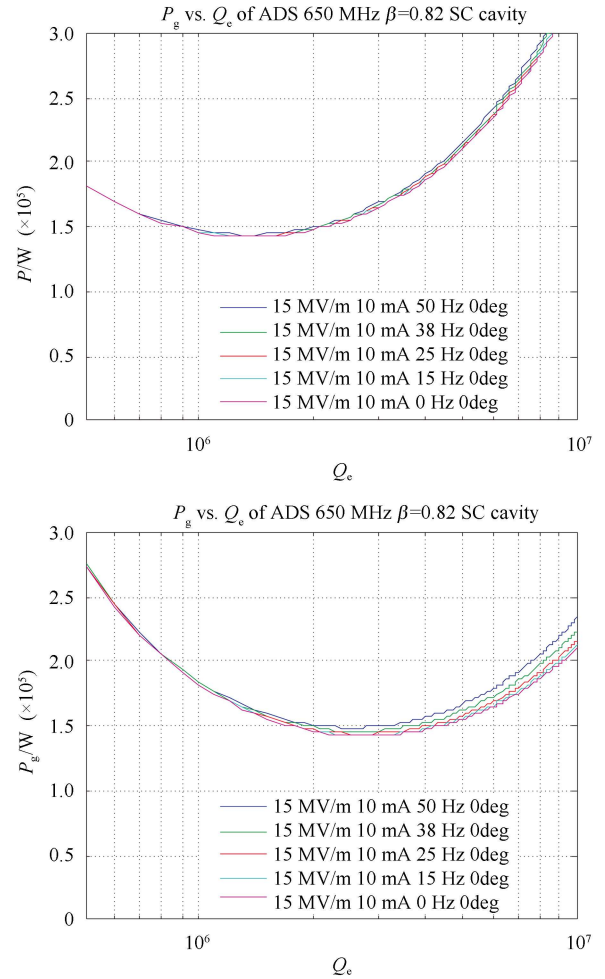

Fig. 6. The RF power versus the input coupler  $Q_e$  of the 650 MHz superconducting cavity. Up:  $Q_0=5 \times 10^9$ ; Down:  $Q_0=1 \times 10^{10}$ .

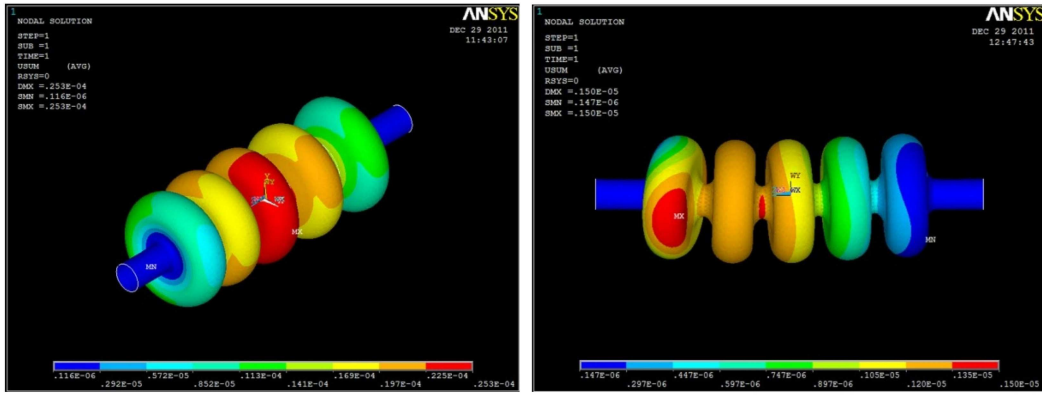

Fig. 7. Cavity shape distortion caused by Lorentz force (static,  $E_{acc}=18$  MV/m). Up: with stiffening ring; Down: without stiffening ring.

Here,  $R_{sh}$  is the shunt impedance,  $V_c$  is the voltage in the cavity,  $i_0$  is the beam dc current,  $\psi$  is the detuning angle, and  $\phi$  is the beam phase.

## 5 The Lorentz force detuning

The Lorentz factor of the cavity is calculated using ANSYS. The cavity wall thickness of 3.7 mm is selected to keep the structural strength, which can also avoid having to use a stiffening ring. The Lorentz factor is  $-0.327$  Hz/(MV/m)<sup>2</sup> with a stiffening ring and  $-1.04$  Hz/(MV/m)<sup>2</sup> without a stiffening ring. Fig. 7 shows the cavity shape distortion caused by static Lorentz force.

## 6 Summary

A 650 MHz  $\beta=0.82$  superconducting cavity has been

designed for the ADS main accelerator from the energy range of 360 MeV to 1500 MeV. The results show that the cavity has a reasonable  $E_{pk}/E_{acc}$  and  $B_{pk}/E_{acc}$  and a large diameter of iris. Multipacting was checked by Track3P and the results show no hard multipacting barrier in the cavity. The external  $Q$  has a large influence on the cavity RF power and the optimal  $Q_e$  value is between  $1 \times 10^6$  to  $4 \times 10^6$  while  $Q_0$  from  $5 \times 10^9$  to  $1 \times 10^{10}$ . The power coupler needs to be adjustable to get different  $Q_e$  as the  $Q_0$  of the cavities is in a wide range. The ANSYS calculation shows that no stiffening ring is needed for a cavity with a properly selected cavity wall thickness as the Lorentz factor  $K_L$  is  $-1.04$  Hz/(MV/m)<sup>2</sup> without the stiffening ring.

*We wish to thank the Advanced Computations Department of SLAC for providing the ACE3P code suite and related resources.*

## References

- 1 GAO J, ZHAI J Y, PAN W M et al. Sci. China Phys. Mech. Astron, 2011, **54**(Suppl. 2): s154—s159
- 2 Yakovlev V et al. In Proceedings of IPAC'10. Kyoto, Japan, 2010, MOPD061
- 3 <http://www.srf.mil.infn.it/Members/pierini>
- 4 GE L X et al. In Proceedings of PAC09. Vancouver, BC, Canada, 2009, WE5PFP020
- 5 Delayen J. RF Fundamentals and Beam Loading. USPAS, 2008, Maryland U. <http://uspas.fnal.gov/materials/08UMD/RF%20Fundamentals.pdf>